

CERTIFICATE

Certified Passive House Component

Component-ID 1641cw03 valid until 31st Decemer 2023

Passive House Institute
Dr. Wolfgang Feist
64283 Darmstadt
Germany

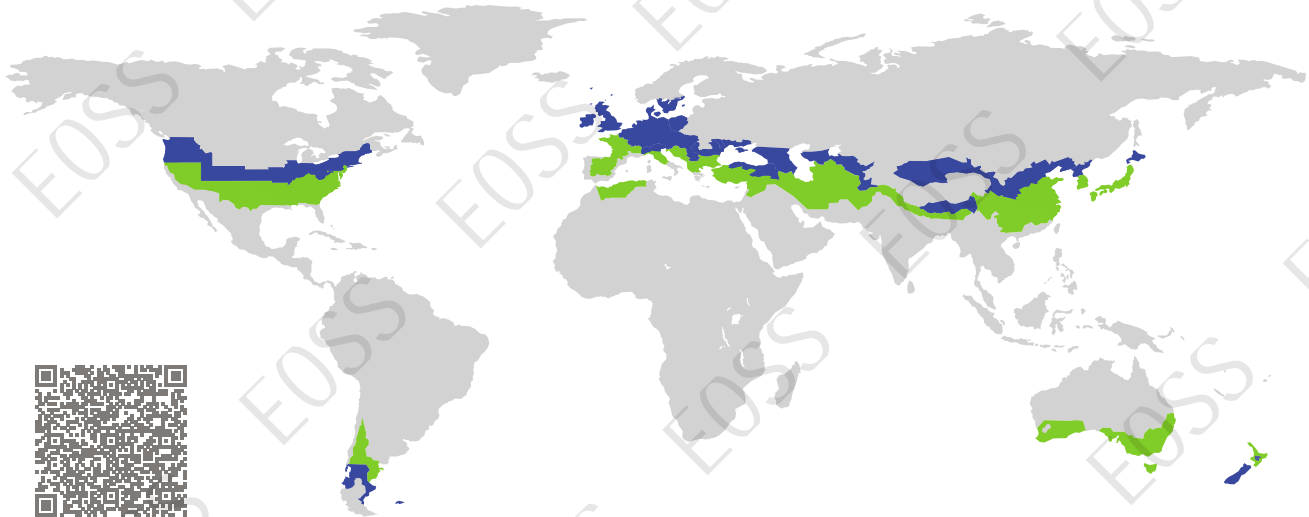

Category: **Curtain Wall**
Manufacturer: **Shandong Huajian Aluminium Group Co.,LTD, Shandong Province, China**
Product name: **EF60HI Passive Curtain Wall**

This certificate was awarded based on the following criteria for the cool, temperate climate zone

Comfort $U_{CW} = 0.80 \leq 0.80 \text{ W}/(\text{m}^2 \cdot \text{K})$
 $U_{CW, \text{installed}} \leq 0.85 \text{ W}/(\text{m}^2 \cdot \text{K})$
with $U_g = 0.70 \text{ W}/(\text{m}^2 \cdot \text{K})$

Hygiene $f_{Rsi=0.25} \geq 0.70$

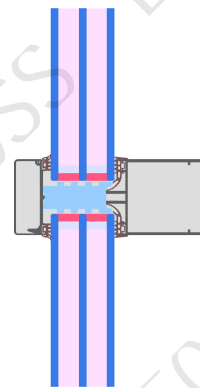

cool, temperate climate



CERTIFIED COMPONENT

Passive House Institute

Passive House
efficiency class

phE

phD

phC

phB

phA

www.passivehouse.com

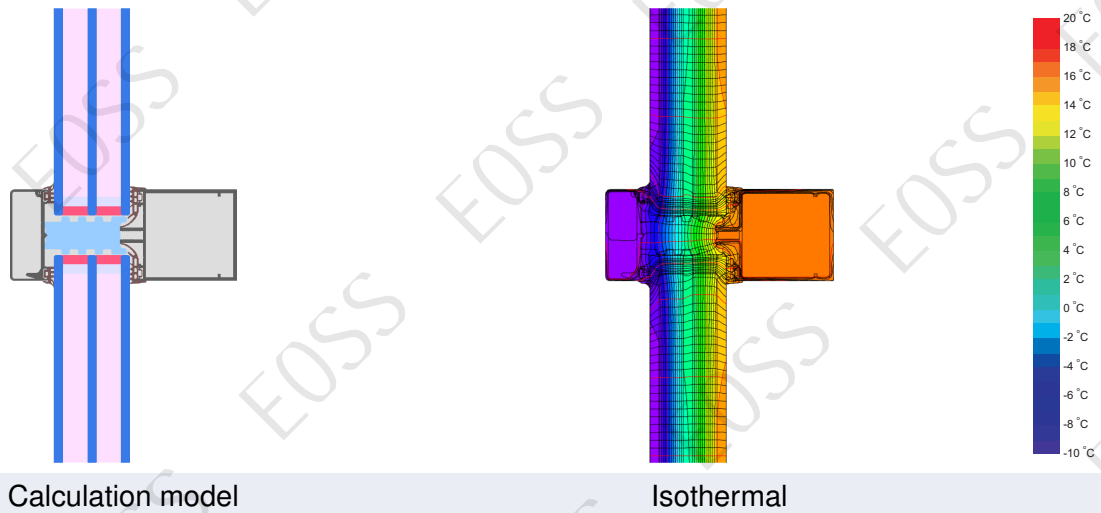

Description

Aluminium mullion and transom facade, standard values used for screw and glass carrier (plastic with metal screws) Insulation: polyethylene foam (0,038 W/(mK)). Pane thickness: 50 mm (6/16/6/16/6 mm). Spacer: TGI Precision with DOWSIL 3364 Warm Edge IG Sealant.

Explanation





The element U-values were calculated for the test element size of 1.20 m × 2.50 m with $U_g = 0.70 \text{ W}/(\text{m}^2 \cdot \text{K})$. If a higher quality glazing is used, the element U-values will improve as follows:

Glazing	$U_g =$	0.70	0.69	0.58	0.53	$\text{W}/(\text{m}^2 \cdot \text{K})$
		↓	↓	↓	↓	
Element	U_{CW}	0.80	0.79	0.69	0.64	$\text{W}/(\text{m}^2 \cdot \text{K})$

Transparent building components are sorted into efficiency classes depending on the heat losses through the opaque part. The frame U-Values, frame widths, thermal bridges at the glazing edge and the glazing edge lengths are included in these heat losses. A more detailed report of the calculations performed in the context of certification is available from the manufacturer.

The Passive House Institute has defined international component criteria for seven climate zones. In principle, components that have been certified for climate zones with higher thermal requirements may also be used in climates with less stringent requirements. In a particular climate zone it may make sense to use a component of a higher thermal quality which has been certified for a climate zone with more stringent requirements.

Further information relating to certification can be found on www.passivehouse.com and passipedia.org.

Frame values		Frame width b_f mm	U -value frame U_f^1 W/(m ² · K)	Ψ -glazing edge Ψ_g W/(m · K)	Temp. Factor $f_{Rsi=0.25}$ [-]
Mullion Fixed	(0M1) 	60	0.96	0.033	0.82
Transom Fixed	(0T1) 	60	0.96	0.033	0.81
Bottom Fixed	(FB1) 	60	0.97	0.032	0.80
Top Fixed	(FH1) 	60	0.97	0.032	0.80
Lateral Fixed	(FJ1) 	60	0.97	0.032	0.81
Spacer: Technoform-Spacer SP16			Secondary seal: DOWSIL™ 3364 Warm Edge IG Sealant		

Thermal glass carrier bridge ² $\chi_{GT} = 0.004$ W/K

Validated installations

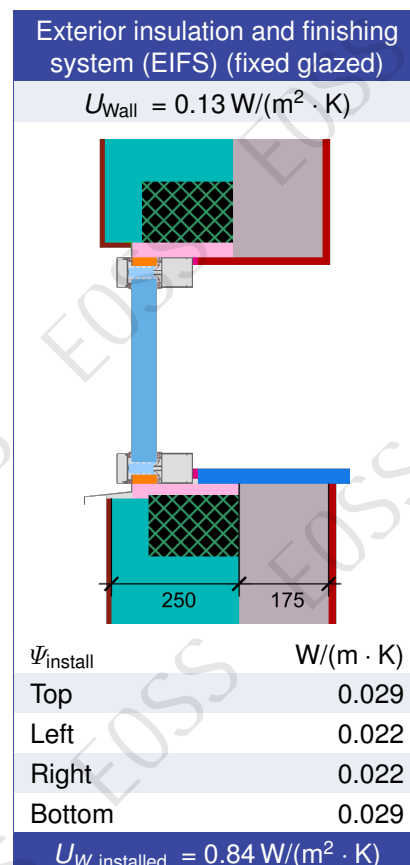
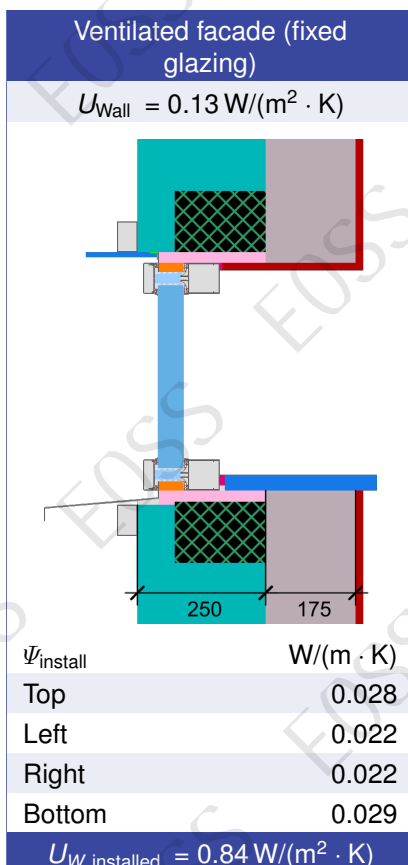

¹ Includes $\Delta U = 0.30$ W/(m² · K). Standard value

² Standard value. Glass carrier type: Non-Metallic Glass Carrier with Screws

